

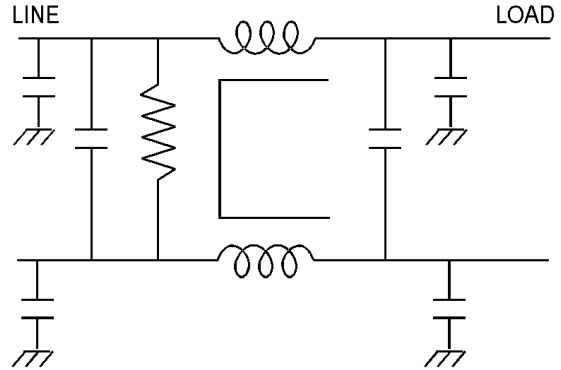

# MM-0637A-40D

Operating Voltage = 48 Vdc (Typical)  
 Operating Voltage Max. = 0—75Vdc  
 Operating Current = 40 Amp  
 Operating Temp Range = -40 to 50 C (see chart)  
 Storage temperature = -55—100 C  
 Dielectric Withstanding Voltage  
   Line to Line: 707 Vdc for 1 minute  
   Line to Case: 2250 Vdc for 1.0 min

### Safety Agency Approvals

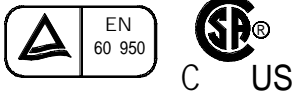

OPERATING TEMPERATURE VS. LOAD CURRENT

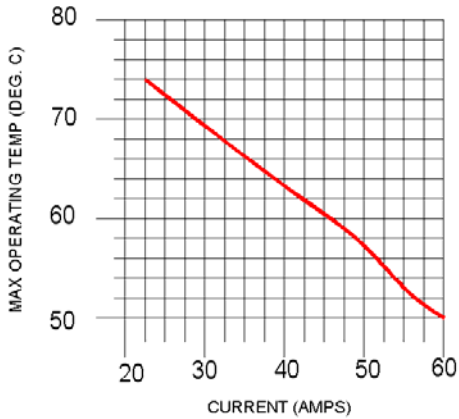

INSERTION LOSS vs. FREQUENCY

